

# PROMISE Vess™ A2000 Series



## Storage Solutions Designed for Surveillance Vess A2200 & A2600 NVR Storage Appliances

### Features

#### Optimized for Surveillance

NVR storage appliance optimized for IP video surveillance

#### Extensive VMS Support

Certified/tested with the world's leading video management software

#### Midsize to Large-Scale Solutions

Ideal for up to over a hundred full-HD IP cameras making it perfect for banking, retail, gaming, manufacturing, and many more industries

#### Cost Effective & Scalable

Integrated solution results in less management overhead, plus it's easy & affordable to add capacity with the Vess R2000 external storage series

#### Easy to Administer & Maintain

Hot swappable drive bays, redundant power supplies, & One Plug Auto Service ensure Vess is incredibly easy to administer & maintain

### Engineered for Video Surveillance

The Vess A2000 Series NVR storage appliance is engineered specifically to be the best solution for midsize to large-scale IP video surveillance deployments. Featuring failsafe protection that provides continuous recording without dropping frames under live playback conditions, it is ideal for 32 to over a hundred full-HD IP cameras, making it perfect for banking, retail, gaming, manufacturing, and many more industries.

### Reduces Deployment Costs and Complexity

The Vess A2000 Series reduces support and equipment costs because there is no separate RAID storage unit to manage, eliminating the need for a server, controller cards, external cables, and a separate storage enclosure. Additionally, the Vess A2000 Series reduces interoperability conflicts caused when integrating different hardware.

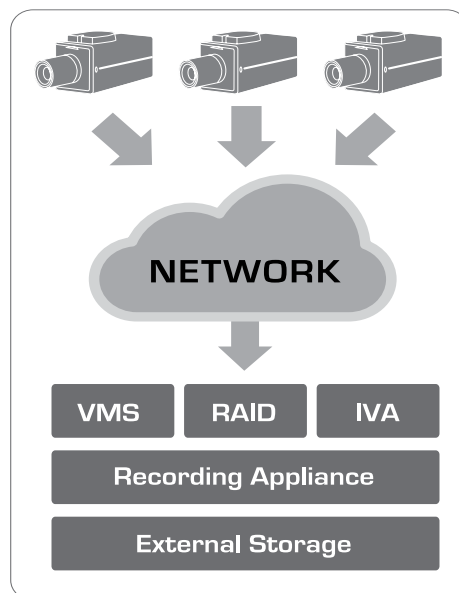

Generic Practice

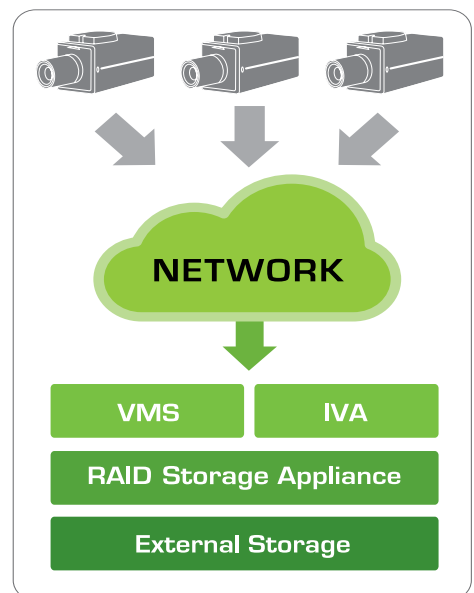

PROMISE Proposal



# Your Solution to Security



## Integrated Solution - Easier to Manage & Grow

The Vess A2000 Series integrates the recorder and storage in a single solution making it significantly easier to scale as your business grows. Security practitioners can easily scale with no user configuration, just plug and add. When external storage is a must, easily scale up with PROMISE's Vess storage series, creating a total video surveillance solution that combines a recording appliance and external storage.

## Support for Security Partners



PROMISE has certified and validated the Vess A2000 appliance with the top solutions in the industry, including applications from AxonSoft, Genetec, ONSSI, SeeTec, Milestone Systems, and more, offering customers more flexibility when building surveillance deployments. Plus, the Vess A2000 Series now supports the Milestone XProtect plug-in which allows users to manage the Vess A2000 series via the user interface of XProtect, making it significantly more convenient for users to manage their storage.

## Surveillance Solution Planner

PROMISE Surveillance Project Design Tool 2.0 takes video surveillance solution planning into next level. Planner 2.0 provides recommendations for deployments and overall topology based on requirements input by the user. The full report indicates a specific number of cameras, bandwidth and storage capacity for each deployment. In addition, three widely used surveillance software platforms, Milestone, Axonsoft and SeeTec, are available for inclusion in the plan. Users can select a preferred VMS or use it to compare planner outcomes with alternative VMS options.

Try it on: [www.promise.com/Promotion/Surveillance-Project-Design-Tool](http://www.promise.com/Promotion/Surveillance-Project-Design-Tool)

## System Video Throughput

FPS	Model	HD	1.3MP	2MP	Full HD
20		107	68	55	49
25		68	62	49	42
30		64	59	42	32
20		130	117	77	71
25		117	99	71	65
30		108	88	65	57

**Recommended Products**



**Notes**

- The number of NVR appliances used in a below cluster (0-8 option only). N
- An asterisk (\*) or (S) of RAID Storage and JBOD Expansion indicates it is a single controller (S) or dual controller (S) system.

**Table Summary**

Camera Group ID	Camera Count	Required Bandwidth	Required Storage	Video Sources
1	44	330 Mbps	224,227 TB	Cam1 - 44
2	44	330 Mbps	224,227 TB	Cam1 - 44
3	12	90 Mbps	61,153 TB	Cam1 - 12

**Notes**

- An example of Video Source notation: "Config1 - 48" means a Video Source with Video Settings: "Config1" and has 48 cameras using the Config1 configuration set.
- Each camera group is assigned to a particular NVR deployment. For example, Camera Group 1 belongs to NVR 1, Camera Group 2 to NVR 2, and so on.

NOTE: The testing scenario is based on multipurpose testing criteria(CPU utilization < 70%)

NOTE: The statistics result in System Video Throughput were produced running Milestone XProtect Corporate 2013 on a Vess A2000 series with fully populated storage enclosures and 8GB memory. Video settings used were H.264 and High Video Quality compression



## Vess A2200/2600 Front and Back Panels



### Vess A2200/2600 Front and Back Panels

#### Vess A2200

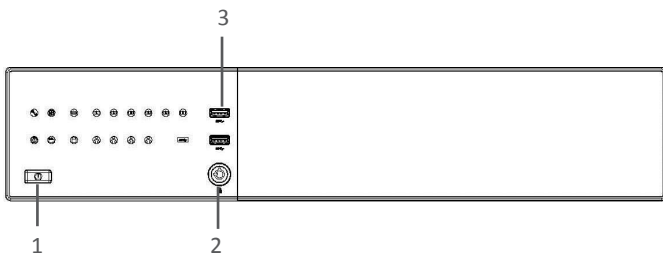

#	Icon	Item	Description
1		Power Button	Turns the device on and off
2		Secure Panel Lock	Provides security for installed hard disks & cooling unit
3		2x USB 3.0 Ports	Compatible with USB 3.0 and earlier devices

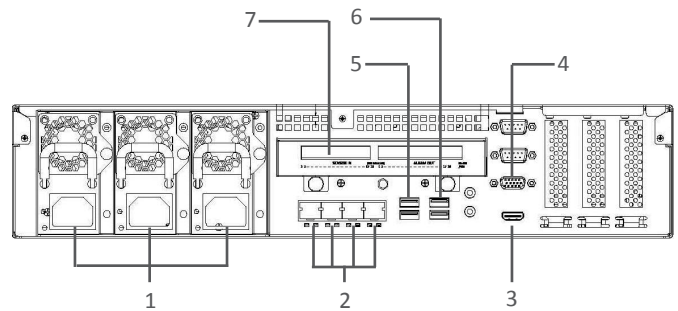

#	Icon	Item	Description
1		Redundant Power	3 N+1 power supplies
2		4x Ethernet Ports	For connection to an Ethernet network
3		HDMI Port	Connects to HDMI monitor
4		VGA Port	Connects to VGA monitor
5		2x USB 3.0 Ports	Compatible with USB 3.0 and earlier devices
6		2x USB 2.0 Ports	Connects to USB devices
7		IO Terminal Ports	Sensor Input/Alarm Output

#### Vess A2600

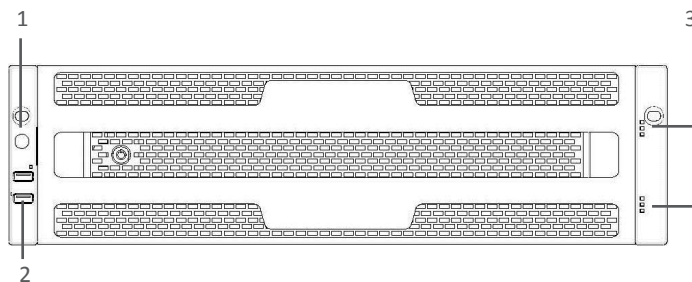

#	Icon	Item	Description
1		Power Button	Turns the device on and off
2		2 USB 2.0 Ports	Connects to USB devices
3		Power & Status LEDs	Indicates drive status and activity

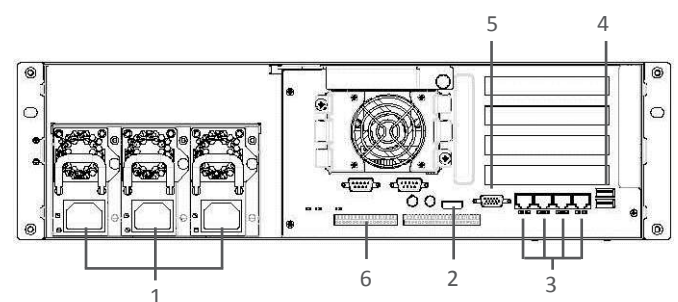

#	Icon	Item	Description
1		Redundant Power	3 N+1 power supplies
2		HDMI Port	Connects to HDMI monitor
3		4x Ethernet Ports	For connection to an Ethernet network
4		2 USB 2.0 Ports	Connects to USB devices
5		VGA Port	Connects to VGA monitor
6		IO Terminal Ports	Sensor Input/Alarm Output

\*Note: The Vess A2600 is shown with the front bezel attached

## Technical Specifications

	Vess A2200	Vess A2600
<b>General Information</b>		
Camera Range <sup>2</sup>	32-64	64-128
Form Factor	2U, 19" Rackmount	3U, 19" Rackmount
Number Of Drives	6 Drives (3.5")	16 Drives (3.5")
Drive Type	SATA (6Gb/s <sup>1</sup> or 3Gb/s), NCQ, TCQ, Hot Swappable	
# of Controllers	Single	
System Processor	Intel® Core™ i3 Dual-core 4-thread	Intel® Xeon® E3 Quad-core 8-thread
System Memory	8GB Default (Max 16GB)	8GB Default (Max 16GB)
I/O Interface	4x Gigabit Ethernet	
Storage Expansion	Optional Vess iSCSI Storage	
Max # of HDDs Supported	Up to 118 drives through iSCSI & JBOD expansion	Up to 128 drives through iSCSI & JBOD expansion

### Other Interfaces

# of USB Ports	4x USB 3.0, 2x USB 2.0	4x USB 2.0
PCI Express Ports	1x 16-lane Gen 2.0 PCIe, 2x 8-lane Gen 2.0 PCIe	1x 16-lane Gen 2.0 PCIe, 3x 8-lane Gen 2.0 PCIe
Graphics	D-sub VGA and HDMI	
Serial Interfaces	2x RS-232C (D-sub 9-pin)	
Audio & Microphone	2x 3.5mm Audio Jack	

### Sensor Input/Alarm Output

Sensor In	Compatible w/ DC3.3V to 24V, photo coupler input x 8	
Alarm Out	Max. DC 24V/1A, mechanical relay output x 8	

### RAID Operational Feature

RAID Levels	0, 1, 1E, 3, 5, 6, 10 (0+1), 30, 50 Any combination can exist at the same time	0, 1, 1E, 3, 5, 6, 10 (0+1), 30, 50, 60 Any combination can exist at the same time
Hot Spares	Multiple global or dedicated hot-spare drives with revertible option	
Max. LUNs per System/Array	256/32	

### Software

Preloaded OS (64-bit)	Windows Embedded Standard 7 Runtime (WS7P), Windows Server 2012 R2 Standard or Linux	
Management Tools	Graphical UI/SNMP via Ethernet, CLI/CLU via Ethernet or Graphics, OPAS Service via USB, SDK or API for Integration	
Appliance Mode	Surveillance Optimization @ Arrays in Normal and Degraded	
Event Notification	Email, SNMP, Buzzer, LEDs	

### System Information

AC Input	100 ~ 240 VAC, 60 ~ 50Hz	
Current (Maximum)	4A (100V); 2A (240V)	
Power Supply	Three redundant 250W, Energy-efficient 80PLUS Certified, 90-264V full-ranging w/PFC, Hot swappable N+1 Design	
BTU	1288 BTU/hr	1729 BTU/hr
Fan	Hot swappable design	
Temperature	5° ~ 40°C (-40° ~ 60°C non-operational)	
Dimensions (H x W x D)	88.2 x 440 x 400 mm (3.5 x 17.3 x 15.7 in)	130.1 x 446.2 x 461 mm (5.1 x 17.6 x 18.1 in)
Weight	10.4kg(22.9 lbs) w/o drives, 14.9kg (32.8lbs) w/drives	15.9kg(35.1 lbs) w/o drives, 27.9kg (61.5lbs) w/drives
Safety/EMI	CE, FCC Class A, BSMI, CB, KC, UL/cUL, CCC	

### Warranty and Support

Warranty	3 year limited warranty	
Optional Accessories	Sliding Rail, 2/4/8GB DDR3 Memory	Sliding Rail, 2/4/8GB DDR3 Memory

<sup>1</sup> Hard disk drive still runs at 3Gb/s speed

<sup>2</sup> The ideal camera range were the test output with fully populated enclosure and 8GB memory under 20FPS, H.264 and High Video Quality compression

Specifications may change without prior notice

